

IMPORTANT - Please ensure you confirm the CAD version number in your CAD approval email to projects@milwoodgroup.com and/or attach the PDF you are approving.
 Any approvals received without confirmation of the version WILL NOT be processed into manufacturing.

FRONT VIEW & ROOF TOP VIEW WITH BUILDING

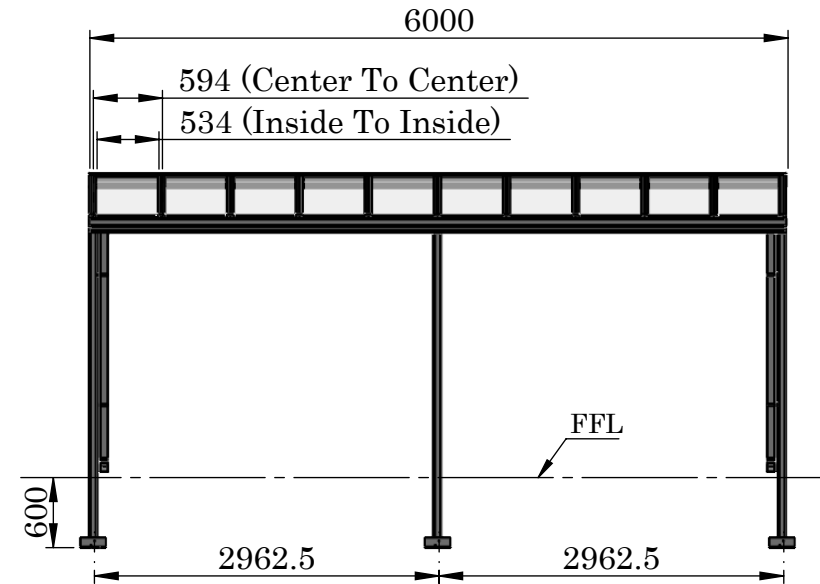
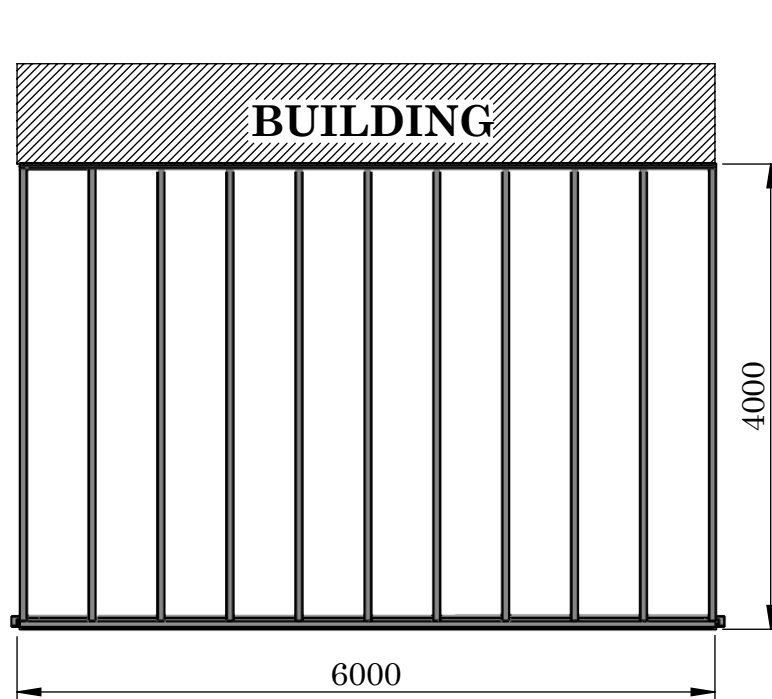

Poly : Clear Polycarbonate Roof Panels.

Total Weight : 177.21 KG.

Aluminium Weight : 120.07 KG.

Poly Weight : 57.14 KG.

Attention: This is a CAD drawing for reference only.
 For Installation Instructions, please refer to the install guide.

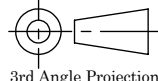
RAL Code	RAL 7016 Anthracite Grey (Textured)	Warehouse	Customer Reference : Sim 16	Drawing Title : Milwood Group					
Colour & Finish of Canopy			Customer Sign :	Product Name : Simplicity 16					
System Delivery Address		Checked By :	Order No. :	 3rd Angle Projection	Page 1 OF 7	Date 27/02/24	Page Size A4 (L)	Scale NTS	Drawn SM
Post Code :					Finish PPC	Issuer ACS	(Tol) +/- 1 mm	Sequence 000001	Revision V1.0
Post Code for installation :	Delivery Date :								

IMPORTANT - Please ensure you confirm the CAD version number in your CAD approval email to projects@milwoodgroup.com and/or attach the PDF you are approving.
 Any approvals received without confirmation of the version WILL NOT be processed into manufacturing.

CROSS SECTION VIEW & ISOMETRIC VIEW

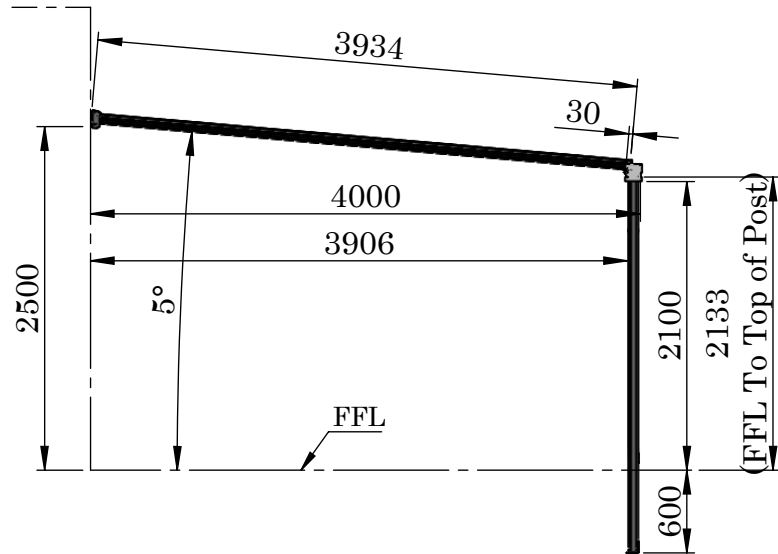
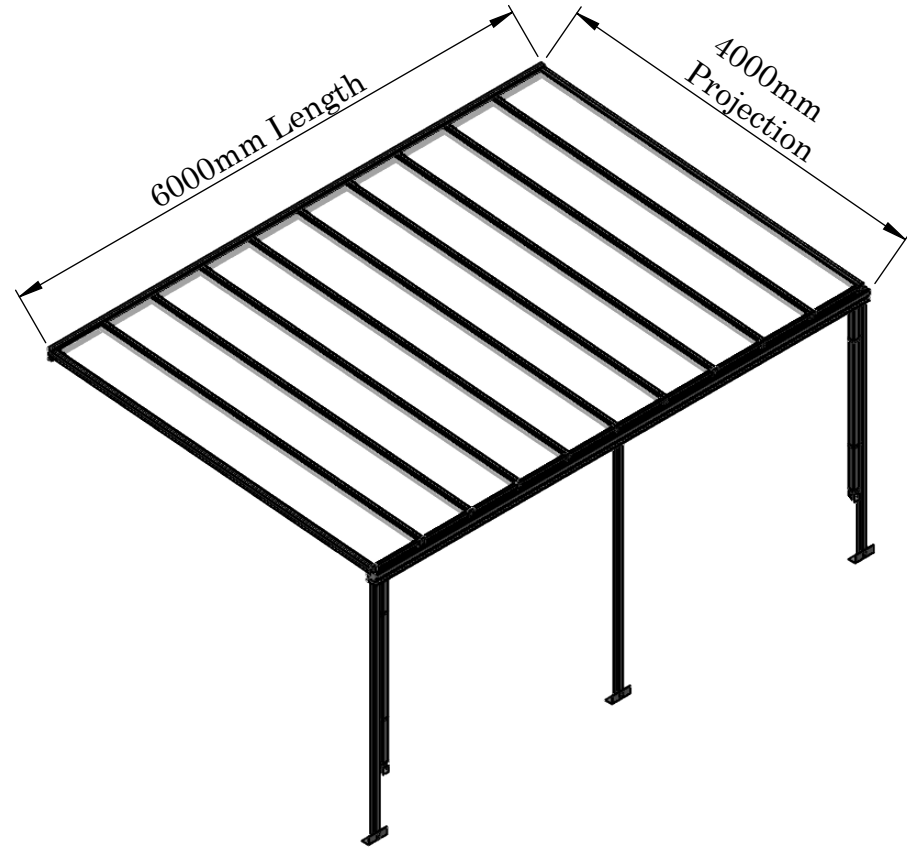
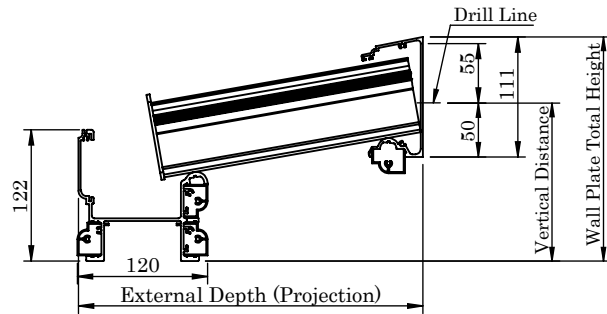

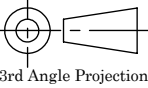
RAL Code	RAL 7016 Anthracite Grey (Textured)	Warehouse	Customer Reference : Sim 16	Drawing Title : Milwood Group					
Colour & Finish of Canopy				Product Name : Simplicity 16					
System Delivery Address		Checked By :	Customer Sign :	 3rd Angle Projection	Page 2 OF 7	Date 27/02/24	Page Size A4 (L)	Scale NTS	Drawn SM
Post Code :			Order No. :		Finish PPC	Issuer ACS	(Tol) +/- 1 mm	Sequence 000001	Revision V1.0
Post Code for installation :	Delivery Date :								

IMPORTANT - Please ensure you confirm the CAD version number in your CAD approval email to projects@milwoodgroup.com and/or attach the PDF you are approving.
Any approvals received without confirmation of the version WILL NOT be processed into manufacturing.

PRODUCT DETAIL

Roof Bar & Sheet Section

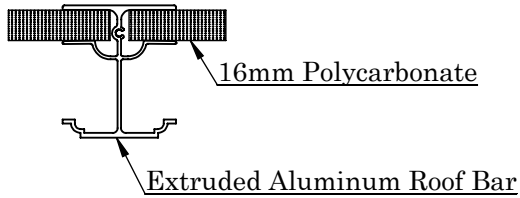

Wall Plate & Roof Bar Section

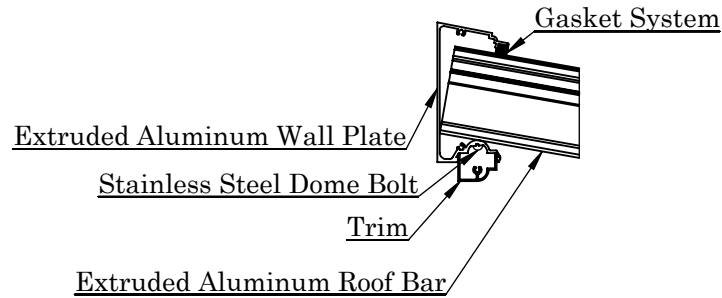

Base & Post Connection Information

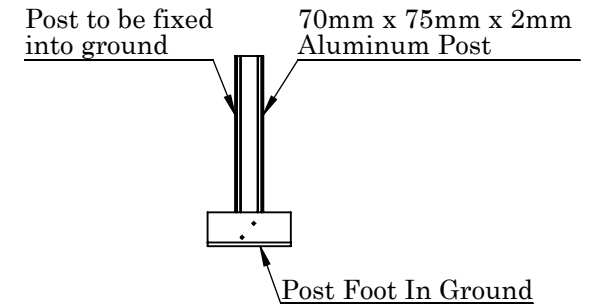

Eaves Beam Roof Bar & Post Section

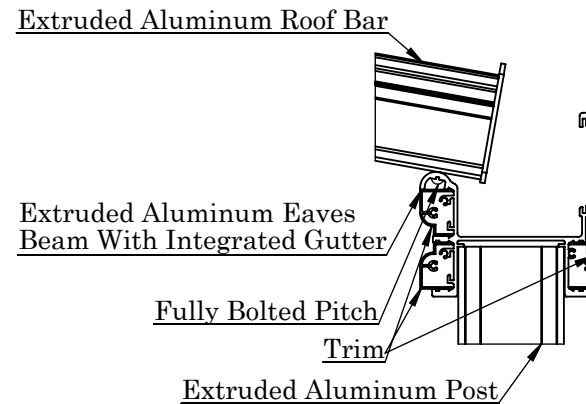

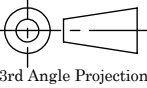
RAL Code	RAL 7016 Anthracite Grey (Textured)	Warehouse	Customer Reference : Sim 16	Drawing Title : Milwood Group					
Colour & Finish of Canopy			Customer Sign :	Product Name : Simplicity 16					
System Delivery Address		Checked By :	Order No. :	 3rd Angle Projection	Page 3 OF 7	Date 27/02/24	Page Size A4 (L)	Scale NTS	Drawn SM
Post Code :					Finish PPC	Issuer ACS	(Tol) +/- 1 mm	Sequence 000001	Revision V1.0
Post Code for installation :	Delivery Date :								

IMPORTANT - Please ensure you confirm the CAD version number in your CAD approval email to projects@milwoodgroup.com and/or attach the PDF you are approving.
Any approvals received without confirmation of the version **WILL NOT** be processed into manufacturing.

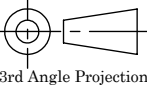
ITEM NO.	Simplicity 16 System RAL 7016 Anthracite Grey (Textured)					Items Cut/Pack	Quality Checked	Packed & Ready for Dispatch		
	PRODUCT CODE	DESCRIPTION	QTY.	LENGTH	Size Checked					
CUTTING LIST - SIM 16 COMPONENTS										
1	S16/MB/7016	RAL7016 Anthracite Grey Sim 16 Main Bar (FTX)	9	3934mm						
2	S16/EB/7016	RAL7016 Anthracite Grey Sim 16 End Bar (FTX)	2	3934mm						
3	S6/S16/WP/7016	RAL7016 Anthracite Grey Sim 6 & 16 Wall Plate (FTX)	1	6000mm						
4	S6/S16/GUT/7016	RAL7016 Anthracite Grey Sim 6 & 16 Gutter (FTX)	1	6000mm						
5	S6/S16/TRIM/7016	RAL7016 Anthracite Grey Sim 6 & 16 Gutter & Wall Plate Trim (FTX)	4	6000mm						
6	S16/FSEC/BOT/7016	RAL7016 Anthracite Grey 16mm F Section (Bottom) (FTX)	10	534mm						
7	S16/FSEC/TOP/7016	RAL7016 Anthracite Grey Sim 16 F Section (Top)	10	534mm						
8	S6/S16/STDPOST/7016	RAL7016 Anthracite Grey Sim 6 & 16 Standard Post (FTX)	3	3000mm						
9	S6/S16/SQPOST/7016	RAL7016 Anthracite Grey Sim 6 & 16 Square Post (FTX)	0							
10	SX/POST/7016/6M	RAL7016 Anthracite Grey Simplicity Xtra Post (FTX) 6M	0							
11	S6/BARGAS/WP	Sim 6 Wall Plate Gasket	1	6000mm						
12	S6/INF/7016	RAL7016 Anthracite Grey Sim 6 Gutter Infill (FTX)	0							
13	DRAIN/SQDP/BL	Black Square Downpipe 5.5m 65mm	2	2750mm						
14	DRAIN/INTDP	40mm Internal Kit Down Pipe 3m	0							
FIXTURES LIST - SIM 16 COMPONENTS										
15	Fastener 25	M5 Black Domed Hex Head Cap	57							
16	Fastener 10	no 10 x 1 hex self tapper ab zp din.7976c zinc plated	28							
17	Fastener 31	M6x20 Pan Pozi Screw	53							
18	Fastener 2	No12 x Self Driller 1/1.4	29							
19	Fastener 3	M6 NYLOC INSERT NUT ST/ST A4	53							
RAL Code		RAL 7016 Anthracite Grey (Textured)	Warehouse	Customer Reference : Sim 16		Drawing Title : Milwood Group				
Colour & Finish of Canopy				Product Name : Simplicity 16						
System Delivery Address		Checked By :	Customer Sign :		 3rd Angle Projection	Page	Date	Page Size	Scale	Drawn
Post Code :			Order No. :			4 OF 7	27/02/24	A4 (L)	NTS	SM
Post Code for installation :			Delivery Date :		Finish	Issuer	(Tol) +/- 1 mm	Sequence	Revision	
				PPC	ACS		000001	V1.0		

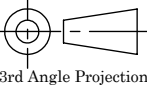
IMPORTANT - Please ensure you confirm the CAD version number in your CAD approval email to projects@milwoodgroup.com and/or attach the PDF you are approving. Any approvals received without confirmation of the version WILL NOT be processed into manufacturing.										
ITEM NO.	PRODUCT CODE	DESCRIPTION	QTY.	LENGTH	Size Checked	Items Cut/Pack	Quality Checked	Packed & Ready for Dispatch		
END PLATES LIST - SIM 16 COMPONENTS										
20	S6/S16/MBEND/7016	RAL7016 Anthracite Grey Sim 6 & 16 Main Bar End Plate (FTX)	9							
21	S16/BARENDOFF/7016	RAL7016 Anthracite Grey Sim 16 Bar End Plate Off Set Hole (FTX)	2							
22	S6/S16/WPEND/7016	RAL7016 Anthracite Grey Sim 6 & 16 Wall Plate End Plate (FTX)	2							
23	S6/S16/GUTEND/7016	RAL7016 Anthracite Grey Sim 6 & 16 Gutter End Plate (FTX)	2							
24	SX/POSTEND/7016	RAL7016 Anthracite Grey Sim Xtra Post End Plate (FTX)	0							
VICTORIAN UPGRADES - SIM 16 COMPONENTS										
25	VIC/BASE/7016	RAL7016 Anthracite Grey Victorian Base Casting 6 & 16 (FTX)	0							
26	VIC/BRA/7016	RAL7016 Anthracite Grey Gallows Bracket 300mm x 300mm (FTX)	0							
DRAINAGE LIST - SIM 16 COMPONENTS										
27	DP/SHOE/BLACK	Black Down Pipe Shoe	2							
28	DRAIN/DPCLIP/BL	Single Fix Square Downpipe Clip Black	4							
29	DRAIN/SQ90	Black Square Bend 90 degrees	0							
30	DRAIN/112/BL	112 Degree Square Downpipe Bend Black	0							
31	DRAIN/SWIV	40mm Internal Kit Swivel Bend	0							
32	DRAIN/STRJOI	40mm Internal Straight Joiner	0							
33	SNUG/BLACK	Black Pipe Snug	0							
34	DRAIN/SPIG	Downpipe Spigot	2							
RAL Code		RAL 7016 Anthracite Grey (Textured)	Warehouse	Customer Reference : Sim 16		Drawing Title : Milwood Group				
Colour & Finish of Canopy						Product Name : Simplicity 16				
System Delivery Address		Checked By :	Customer Sign :		 3rd Angle Projection	Page	Date	Page Size	Scale	Drawn
Post Code :			Order No. :			5 OF 7	27/02/24	A4 (L)	NTS	SM
Post Code for installation :			Delivery Date :		Finish	Issuer	(Tol) +/- 1 mm	Sequence	Revision	
				PPC	ACS		000001	V1.0		

IMPORTANT - Please ensure you confirm the CAD version number in your CAD approval email to projects@milwoodgroup.com and/or attach the PDF you are approving.
Any approvals received without confirmation of the version WILL NOT be processed into manufacturing.

ITEM NO.	PRODUCT CODE	DESCRIPTION	QTY.	LENGTH	Size Checked	Items Cut/Pack	Quality Checked	Packed & Ready for Dispatch
JOINERS - SIM 16 COMPONENTS								
35	S6/S16/GUTJ/7016	Sim 6 & 16 18x300 Gutter Joiner 7016	0					
36	S6/S16/GUTJ2/7016	RAL7016 Anthracite Grey Sim 6 & 16 61.5 x 300 Gutter Joiner 2 (FTX)	0					
37	S6/S16/GUTJ3/7016	RAL7016 Anthracite Grey Sim 6 & 16 70 x 300 Gutter Joiner 3	0					
POST BRACKETS - SIM 16 COMPONENTS								
38	GEN/BRA	Generic In Ground Post Bracket	3					
39	S6/S16/BTGBRA/7016	RAL7016 Anthracite Grey Sim 6 & 16 Bolt To Ground Post Bracket (FTX)	0					
40	SX/BTGBRA/7016	RAL7016 Anthracite Grey Sim Xtra Bolt To Ground Bracket (FTX)	0					
SILICONE & SPRAY CANS - SIM 16 COMPONENTS								
41	SOUD/BL	Soudall Black	1					
42	AERO/7016	Spray Can RAL7016 Anthracite Grey Textured	1					
43	SEAL/CLEAR	Sikaflex Crystal Clear	1					
POLYCARBONATE								
44	POLY/16/GREYHEAT	16mm Multiwall Polycarbonate Grey Heatshield	0					
45	POLY/16/CLEAR	16mm Multiwall Polycarbonate Clear	10	Length-3914mm x Width-584mm				
46	POLY/16/OPAL	16mm Multiwall Polycarbonate Opal	0					
47	POLY/16/BRONZE	16mm Multiwall Polycarbonate Bronze	0					

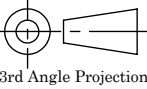
RAL Code		RAL 7016 Anthracite Grey (Textured)		Warehouse	Customer Reference : Sim 16		Drawing Title : Milwood Group					
Colour & Finish of Canopy					Product Name : Simplicity 16							
System Delivery Address				Checked By :	Customer Sign :		 3rd Angle Projection	Page	Date	Page Size	Scale	Drawn
Post Code :					Order No. :			6 OF 7	27/02/24	A4 (L)	NTS	SM
Post Code for installation :		Delivery Date :				Finish	Issuer	(Tol) +/-	Sequence	Revision		
						PPC	ACS	1 mm	000001	V1.0		

IMPORTANT - Please ensure you confirm the CAD version number in your CAD approval email to projects@milwoodgroup.com and/or attach the PDF you are approving.

Any approvals received without confirmation of the version WILL NOT be processed into manufacturing.

POLY DETAIL

Poly Type	16mm Clear Poly
No Of Poly Panel	10
Poly m ²	22.85 m ²

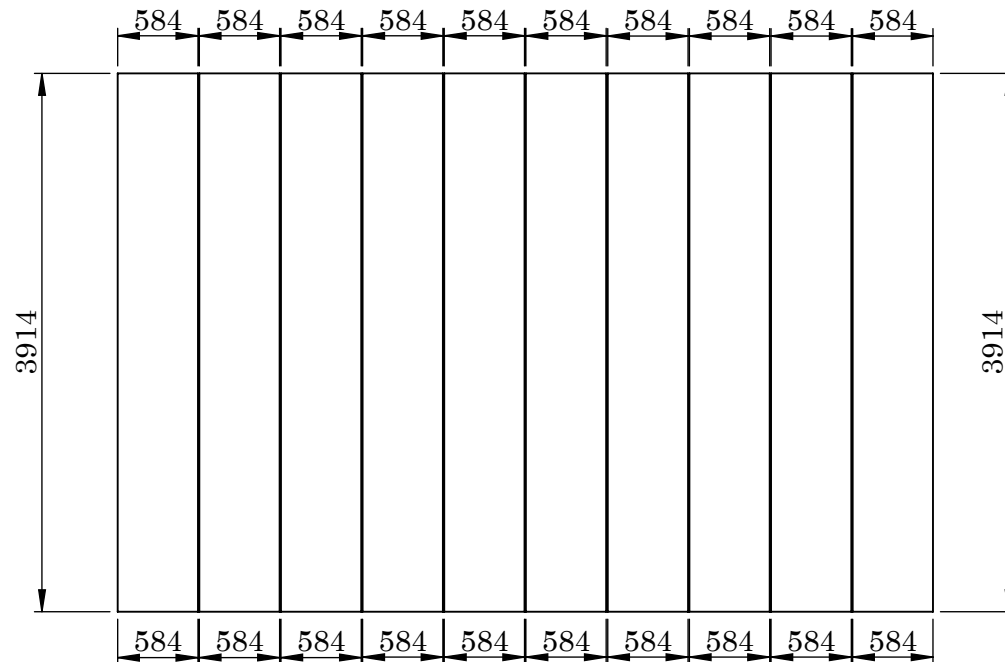

POLY SIZE

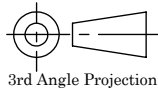
RAL Code	RAL 7016 Anthracite Grey (Textured)	Warehouse	Customer Reference : Sim 16	Drawing Title : Milwood Group					
Colour & Finish of Canopy			Customer Sign :	Product Name : Simplicity 16					
System Delivery Address		Checked By :	Order No. :	 3rd Angle Projection	Page 7 OF 7	Date 27/02/24	Page Size A4 (L)	Scale NTS	Drawn SM
Post Code :					Finish PPC	Issuer ACS	(Tol) +/- 1 mm	Sequence 000001	Revision V1.0
Post Code for installation :	Delivery Date :								