

IMPORTANT - Please ensure you confirm the CAD version number in your CAD approval email to projects@milwoodgroup.com and/or attach the PDF you are approving.
Any approvals received without confirmation of the version **WILL NOT** be processed into manufacturing.

FRONT VIEW & ROOF TOP VIEW WITH BUILDING

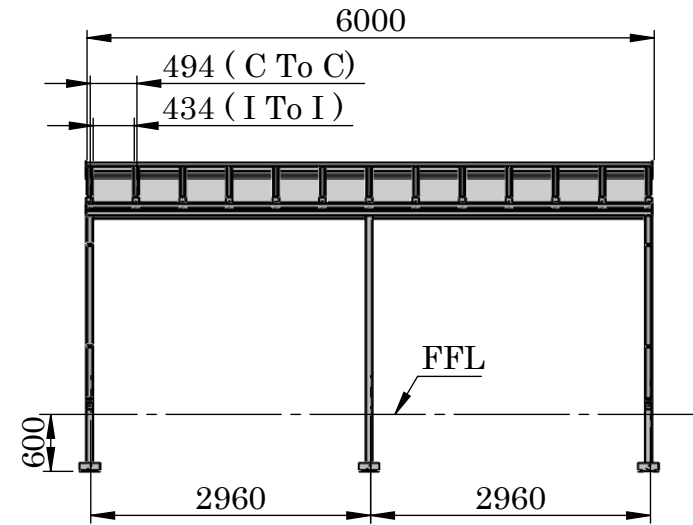
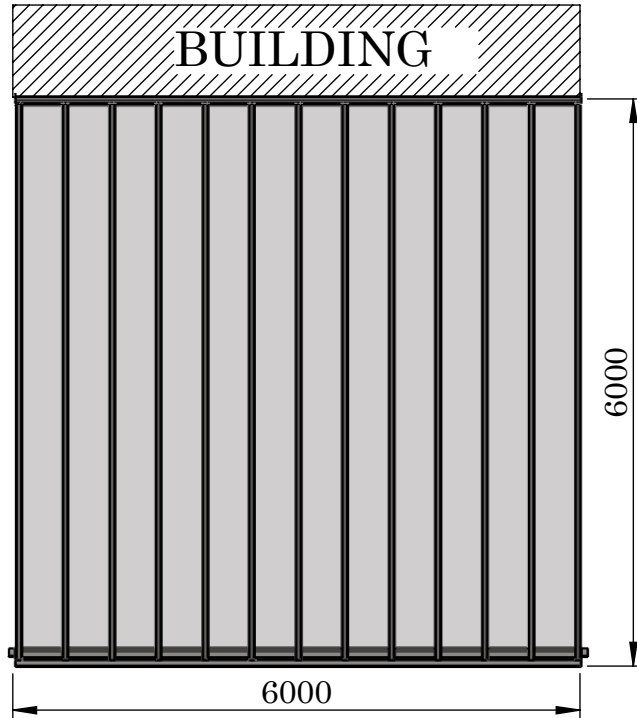

Poly : Clear Polycarbonate Roof Panels.

Total Weight : 464.10 KG.

Aluminium Weight : 330.50 KG.

Poly Weight : 133.59 KG.

Attention: This is a CAD drawing for reference only.
For Installation Instructions, please refer to the install guide.

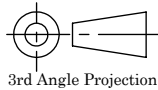
RAL Code	RAL 7016 Anthracite Grey Textured	Warehouse	Customer Reference : Sim 35	Drawing Title : Milwood Group					
Colour & Finish of Canopy			Customer Sign :	Product Name : Simplicity 35					
System Delivery Address		Checked By :	Order No. :	 3rd Angle Projection	Page 1 OF 7	Date 28/02/24	Page Size A4 (L)	Scale NTS	Drawn SM
Post Code :					Finish PPC	Issuer ACS	(Tol) +/- 1 mm	Sequence 000001	Revision V1.0
Post Code for installation :	Delivery Date :								

IMPORTANT - Please ensure you confirm the CAD version number in your CAD approval email to projects@milwoodgroup.com and/or attach the PDF you are approving.
Any approvals received without confirmation of the version **WILL NOT** be processed into manufacturing.

CROSS SECTION VIEW & ISOMETRIC VIEW

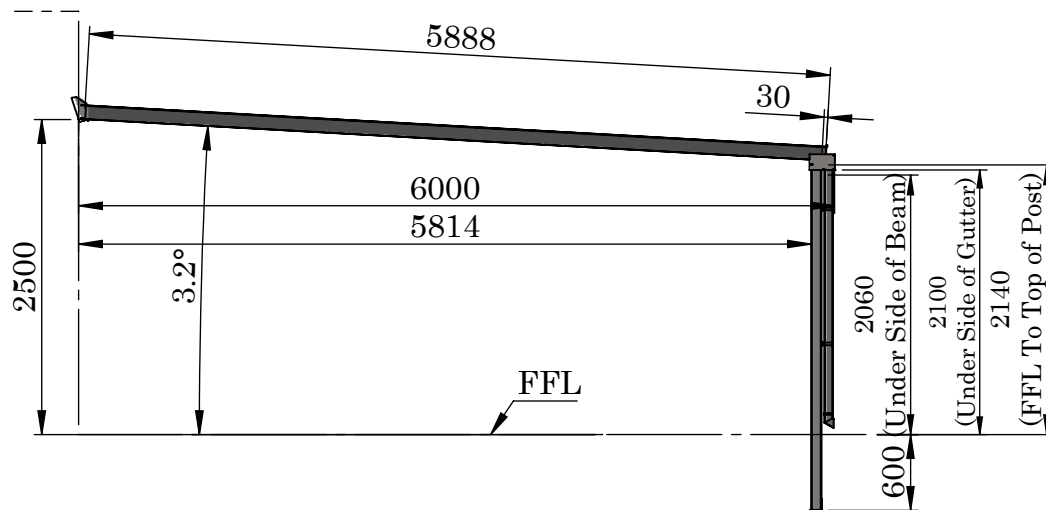
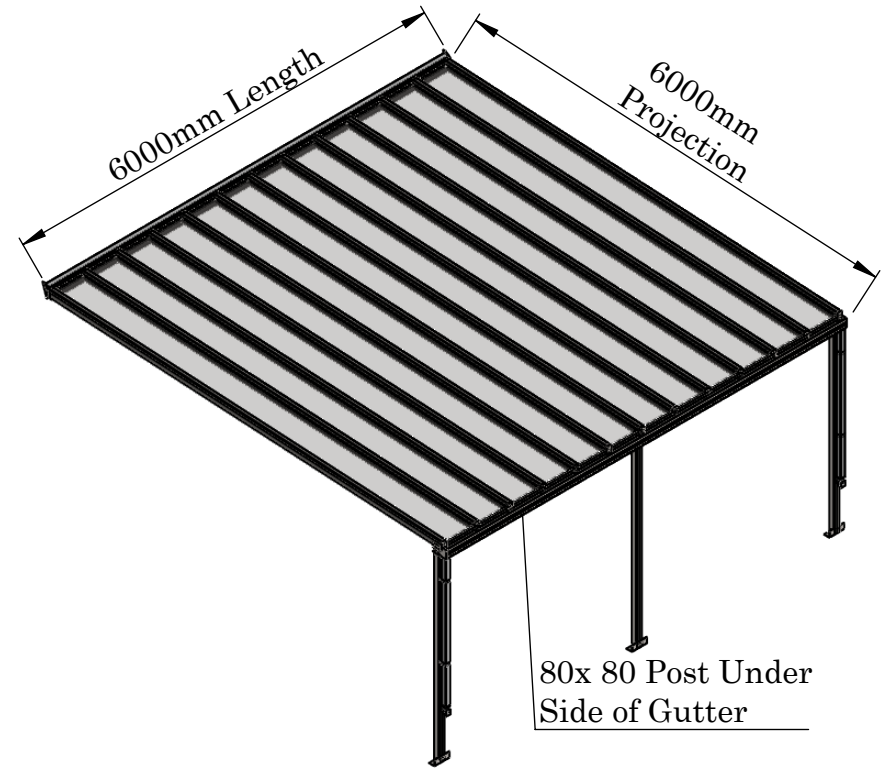
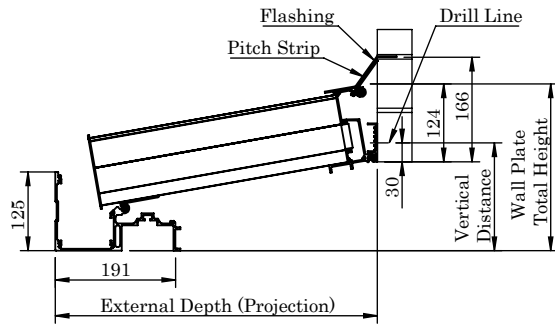

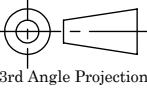
RAL Code	RAL 7016 Anthracite Grey Textured	Warehouse	Customer Reference : Sim 35	Drawing Title : Milwood Group					
Colour & Finish of Canopy			Customer Sign :	Product Name : Simplicity 35					
System Delivery Address		Checked By :	Order No. :	 3rd Angle Projection	Page 2 OF 7	Date 28/02/24	Page Size A4 (L)	Scale NTS	Drawn SM
Post Code :					Finish PPC	Issuer ACS	(Tol) +/- 1 mm	Sequence 000001	Revision V1.0
Post Code for installation :	Delivery Date :								

IMPORTANT - Please ensure you confirm the CAD version number in your CAD approval email to projects@milwoodgroup.com and/or attach the PDF you are approving.
Any approvals received without confirmation of the version **WILL NOT** be processed into manufacturing.

PRODUCT DETAIL

Wall Plate & Roof Bar Section

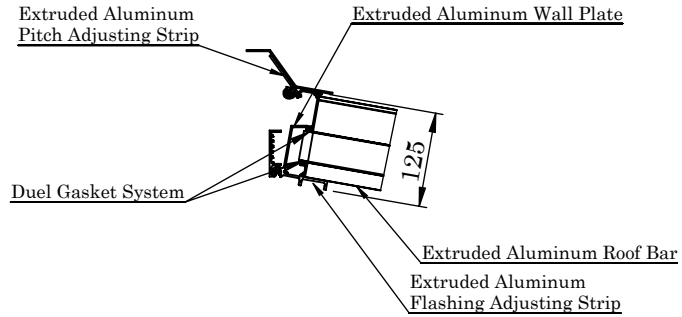

Roof Bar & Sheet Section

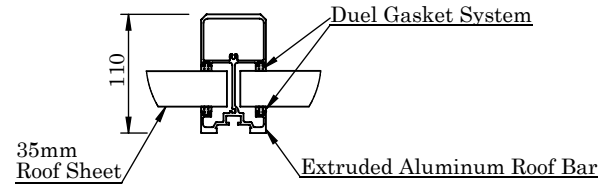

Base & Post Connection Information

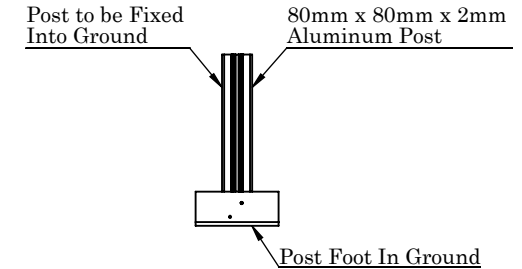

Eaves Beam Roof Bar & Post Section

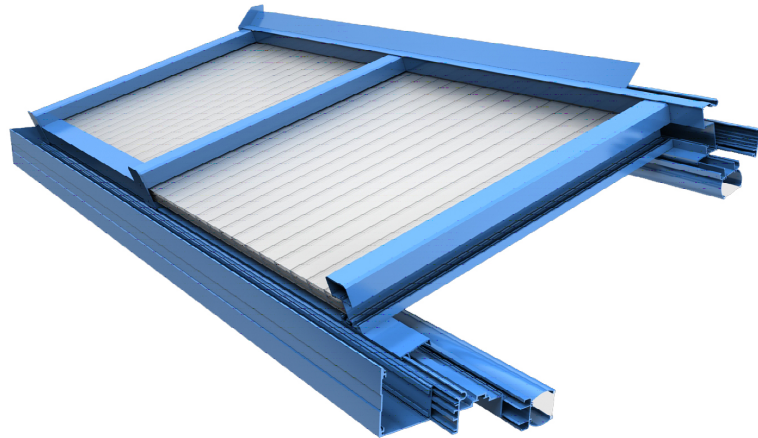
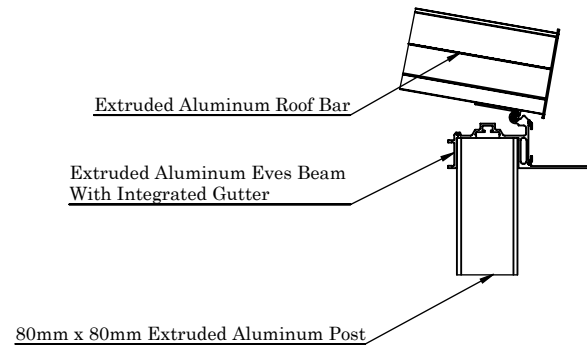

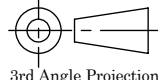
RAL Code	RAL 7016 Anthracite Grey Textured	Warehouse	Customer Reference : Sim 35	Drawing Title : Milwood Group					
Colour & Finish of Canopy			Customer Sign :	Product Name : Simplicity 35					
System Delivery Address		Checked By :	Order No. :	 3rd Angle Projection	Page 3 OF 7	Date 28/02/24	Page Size A4 (L)	Scale NTS	Drawn SM
Post Code :					Finish PPC	Issuer ACS	(Tol) +/- 1 mm	Sequence 000001	Revision V1.0
Post Code for installation :	Delivery Date :								

IMPORTANT - Please ensure you confirm the CAD version number in your CAD approval email to projects@milwoodgroup.com and/or attach the PDF you are approving.
Any approvals received without confirmation of the version **WILL NOT** be processed into manufacturing.

ITEM NO.	Simplicity 35 System RAL 7016 Anthracite Grey (Textured)					Items Cut/Pack	Quality Checked	Packed & Ready for Dispatch
	PRODUCT CODE	DESCRIPTION	QTY.	LENGTH	Size Checked			
CUTTING LIST - SIM 35 RAL 7016 (Textured)								
1	S35/MB/7016	RAL7016 Anthracite Grey Sim 35 Main Bar (FTX)	11	5888mm				
2	S35/MB/7016/4M	RAL7016 Anthracite Grey Sim 35 Main Bar 4000mm (FTX)	0					
3	LIGHT/LENS8	Plastic 8mm Lighting Lens for Sim 6	0					
4	SPP2470	Plastic Lens for Gutter and/or Alfresco Bolster Bars 22MM	0					
5	S35/EB/7016	RAL7016 Anthracite Grey Sim 35 End Bar (FTX)	2	5888mm				
6	S35/WP/7016	RAL7016 Anthracite Grey Sim 35 Wall Plate (FTX)	1	6000mm				
7	S35/SERPIT/7016	RAL7016 Anthracite Grey Sim 35 Serrated Wall Plate Pitch Strip (FTX)	1	6000mm				
8	S35/GUT/7016	RAL7016 Anthracite Grey Sim 35 Gutter (FTX)	1	6000mm				
9	S35/PITSTR/7016	RAL7016 Anthracite Grey Sim 35 Standard Pitch Strip (FTX)	2	6000mm				
10	S35/FSEC/7016	RAL7016 Anthracite Grey Sim 35 F Section (FTX)	12	474mm				
11a	S35/POST/7016	RAL7016 Anthracite Grey Sim 35 Standard Post 80x80 (FTX)	3	3000mm				
11b	S35/POST/7016	RAL7016 Anthracite Grey Sim 35 Standard Post 80x80 (FTX)	2	2880mm				
12	S35/GBGKB	Sim 35 Glazing Bar Bot Gasket	24	5888mm				
13	S35/GBGKT	Sim 35 Glazing Bar Top Gasket	24	5888mm				
14	S35/WPGAS	Sim 35 Wall Plate Gasket	2	6000mm				
15	DRAIN/SQDP/BL	Black Square Downpipe 5.5m 65mm	2	2750mm				

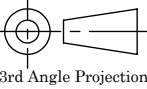
RAL Code		RAL 7016 Anthracite Grey Textured		Warehouse	Customer Reference : Sim 35		Drawing Title : Milwood Group					
Colour & Finish of Canopy					Product Name : Simplicity 35							
System Delivery Address				Checked By :	Customer Sign :		 3rd Angle Projection	Page	Date	Page Size	Scale	Drawn
Post Code :					Order No. :			Finish	Issuer	(Tol) +/-	Sequence	Revision
Post Code for installation :		Delivery Date :				PPC	ACS	1 mm	000001	V1.0		

IMPORTANT - Please ensure you confirm the CAD version number in your CAD approval email to projects@milwoodgroup.com and/or attach the PDF you are approving.
Any approvals received without confirmation of the version **WILL NOT** be processed into manufacturing.

ITEM NO.	PRODUCT CODE	DESCRIPTION	QTY.	LENGTH	Packed & Ready for Dispatch	Items Cut/Pack	Quality Checked	Packed & Ready for Dispatch
FIXTURES LIST - SIM 35 COMPONENTS								
16	Fastener 7	M8 X 30 Bolt SS	23					
17	Fastener 12	M8 Nyloc Nuts	23					
18	Fastener 10	no 10 x 1 hex self tapper ab zp din.7976c zinc plated	49					
19	Fastener 25	M5 Black Domed Hex Head Cap	115					
20	Fastener 8	M8 X 20 SS Bolt	32					
21	Fastener 22	M8 Dome Headed SS Nut	32					
22	Fastener 30	M8 Serrated Washer	39					
23	Fastener 2	No12 x Self Driller 1/1.4	66					
END PLATES LIST - SIM 35 COMPONENTS								
24	S35/BAREND/7016	RAL7016 Anthracite Grey Sim 35 Bar End Plates 35mm (FTX)	13					
25	S35/WPEND/FOAM	Sim 35 Wall Plate End Plate - Foam-ex	2					
26	S35/GUTEND/7016	RAL7016 Anthracite Grey Sim 35 Gutter End Plate (FTX)	2					
VICTORIAN UPGRADES - SIM 35 COMPONENTS								
27	VIC/BRA/7016	RAL7016 Anthracite Grey Gallows Bracket 300mm x 300mm (FTX)	0					
28	S35/VIC/BASE	Sim 35 Base Casting	0					
29	S35/VIC/COL	Sim 35 Collar Casting	0					
DRAINAGE LIST - SIM 35 COMPONENTS								
30	DP/SHOE/BLACK	Black Down Pipe Shoe	2					
31	DRAIN/DPCLIP/BL	Single Fix Square Downpipe Clip Black	4					
32	DRAIN/SQ90	Black Square Bend 90 degrees	0					
33	DRAIN/112/BL	112 Degree Square Downpipe Bend Black	0					
34	DRAIN/SPIG	Downpipe Spigot	2					

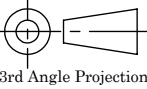
RAL Code	RAL 7016 Anthracite Grey Textured	Warehouse	Customer Reference : Sim 35	Drawing Title : Milwood Group					
Colour & Finish of Canopy			Customer Sign :	Product Name : Simplicity 35					
System Delivery Address		Checked By :	Order No. :	 3rd Angle Projection	Page	Date	Page Size	Scale	Drawn
Post Code :					5 OF 7	28/02/24	A4 (L)	NTS	SM
Post Code for installation :	Delivery Date :			Finish	Issuer	(Tol) +/- 1 mm	Sequence	Revision	
				PPC	ACS		000001	V1.0	

IMPORTANT - Please ensure you confirm the CAD version number in your CAD approval email to projects@milwoodgroup.com and/or attach the PDF you are approving.
Any approvals received without confirmation of the version **WILL NOT** be processed into manufacturing.

ITEM NO.	PRODUCT CODE	DESCRIPTION	QTY.	LENGTH	Packed & Ready for Disepatch	Items Cut/Pack	Quality Checked	Packed & Ready for Disepatch
JOINERS - SIM 35 COMPONENTS								
35	S35/EAVJ1	Sim 35 100 x 300mm Eaves Joiner 1	0					
36	S35/EAVJ2	Sim 35 44 x 300mm Eaves Joiner 2	0					
37	S35/EAVJ3	Sim 35 77 x 300mm Eaves Joiner 3	0					
38	S35/EAVROD	Sim 35 Eaves Joiner Rod	0					
POST BRACKETS - SIM 35 COMPONENTS								
39	S35/INTCLEAT	Sim 35 Internal Post Cleat	3					
40	S35/BTGBRA/7016	RAL7016 Anthracite Grey Sim 35 Bolt To Ground Post Bracket (FTX)	0					
41	GEN/BRA	Generic In Ground Post Bracket	3					
SILICONE & SPRAY CANS - SIM 35 COMPONENTS								
42	SOUD/BL	Soudall Black	1					
43	AERO/7016	Spray Can RAL7016 Anthracite Grey Textured	1					
44	SEAL/CLEAR	Sikaflex Crystal Clear	1					
POLYCARBONATE								
45	POLY/35/BRONZE	35mm Multiwall Polycarbonate BRONZE	0					
46	POLY/35/CLEAR	35mm Multiwall Polycarbonate CLEAR	12	Length-5898mm & Width-484mm				
47	POLY/35/OPAL	35mm Multiwall Polycarbonate OPAL	0					
48	POLY/35/GREY/OPAL/HEAT	35mm Multiwall Polycarbonate GREY & OPAL Heatshield	0					

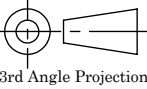
RAL Code		RAL 7016 Anthracite Grey Textured		Warehouse	Customer Reference : Sim 35		Drawing Title : Milwood Group					
Colour & Finish of Canopy					Product Name : Simplicity 35							
System Delivery Address				Checked By :	Customer Sign :		 3rd Angle Projection	Page	Date	Page Size	Scale	Drawn
Post Code :					Order No. :			6 OF 7	28/02/24	A4 (L)	NTS	SM
Post Code for installation :		Delivery Date :			Finish	Issuer	(Tol) +/-	Sequence	Revision			
					PPC	ACS	1 mm	000001	V1.0			

IMPORTANT - Please ensure you confirm the CAD version number in your CAD approval email to projects@milwoodgroup.com and/or attach the PDF you are approving.
 Any approvals received without confirmation of the version **WILL NOT** be processed into manufacturing.

POLY DETAIL

Poly Type	35mm Clear Poly
No. Of Poly Pannel	12
Poly m ²	34.25m ²

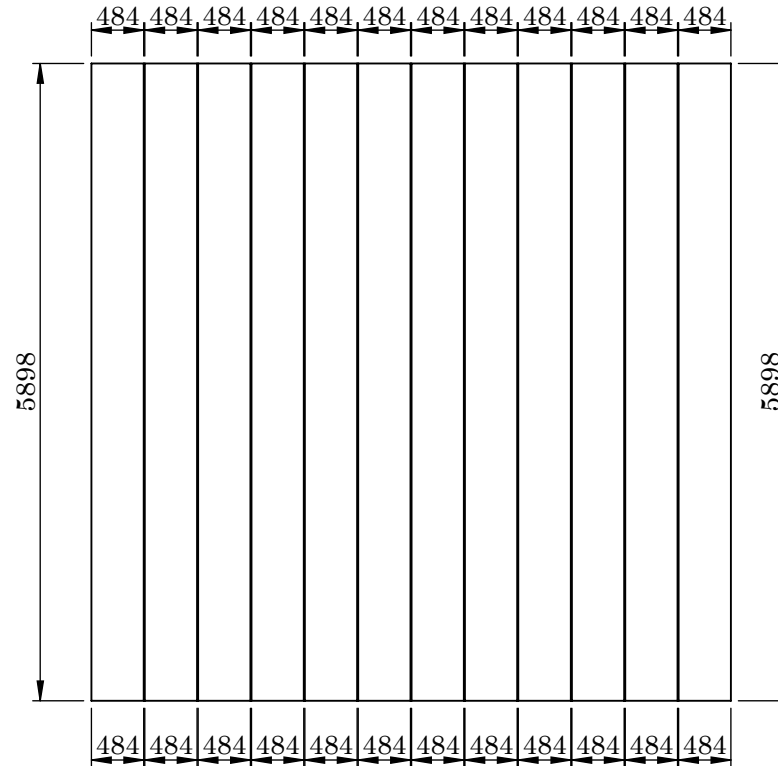

POLY SIZE

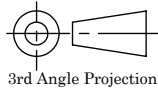
RAL Code	RAL 7016 Anthracite Grey Textured	Warehouse	Customer Reference : Sim 35	Drawing Title : Milwood Group					
Colour & Finish of Canopy				Product Name : Simplicity 35					
System Delivery Address		Checked By :	Customer Sign :	 3rd Angle Projection	Page	Date	Page Size	Scale	Drawn
Post Code :			Order No. :		7 OF 7	28/02/24	A4 (L)	NTS	SM
Post Code for installation :			Delivery Date :	Finish	Issuer	(Tol) +/-	Sequence	Revision	
		PPC	ACS	1 mm	000001	V1.0			