

IMPORTANT - Please ensure you confirm the CAD version number in your CAD approval email to projects@milwoodgroup.com and/or attach the PDF you are approving.
Any approvals received without confirmation of the version **WILL NOT** be processed into manufacturing.

FRONT VIEW & ROOF TOP VIEW WITH BUILDING

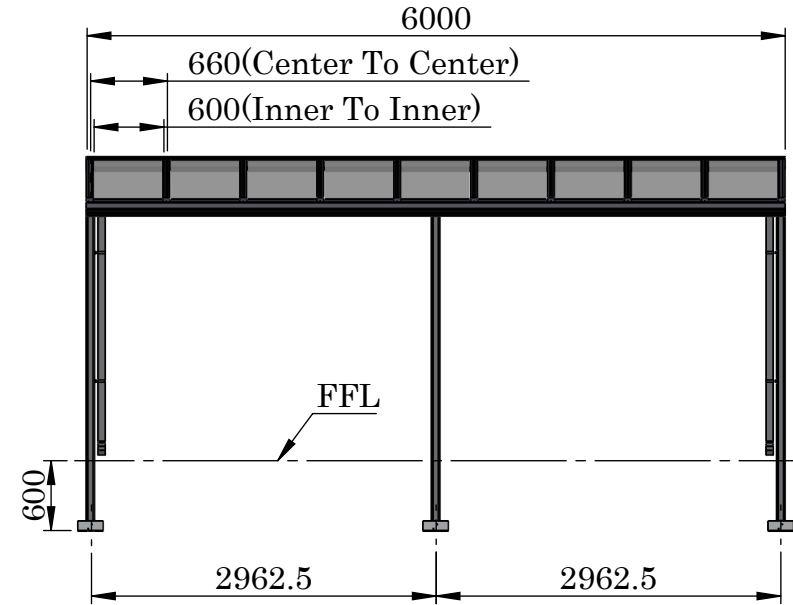
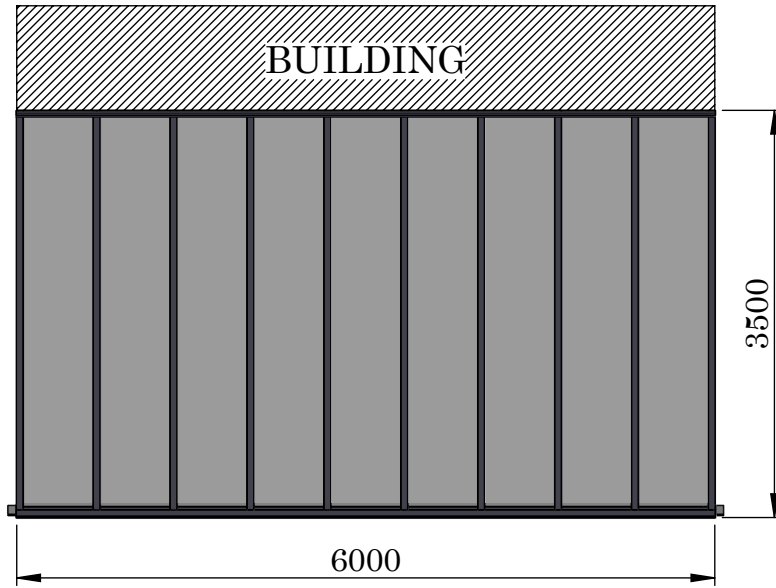

Glass : 6mm Clear Glass Roof Panels.
Total Weight : 422.19 KG.
Glass Weight : 296.95 KG.
Aluminium Weight :125.23 KG.

Attention: This is a CAD drawing for reference only.
For Installation instructions, please refer to the install guide.

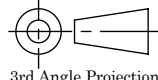
RAL Code	RAL 7016 Anthracite Grey Textured	Warehouse	Customer Reference : Sim 6	Drawing Title : Milwood Group					
Colour & Finish of Canopy			Customer Sign :	Product Name : Simplicity 6					
System Delivery Address		Checked By :	Order No. :	 3rd Angle Projection	Page 1 OF 7	Date 27/02/24	Page Size A4 (L)	Scale NTS	Drawn VA
Post Code :					Finish PPC	Issuer ACS	(Tol) +/- 1 mm	Sequence 000001	Revision V1.0
Post Code for installation :	Delivery Date :								

IMPORTANT - Please ensure you confirm the CAD version number in your CAD approval email to projects@milwoodgroup.com and/or attach the PDF you are approving.
 Any approvals received without confirmation of the version **WILL NOT** be processed into manufacturing.

CROSS SECTION VIEW & ISOMETRIC VIEW

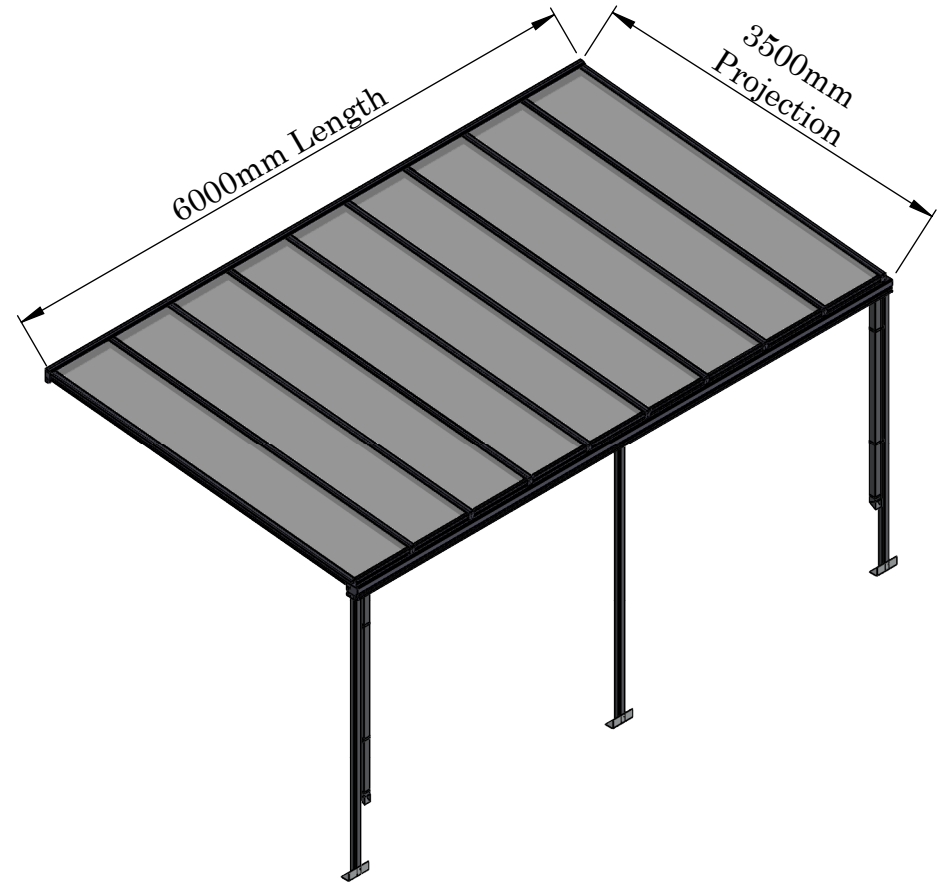
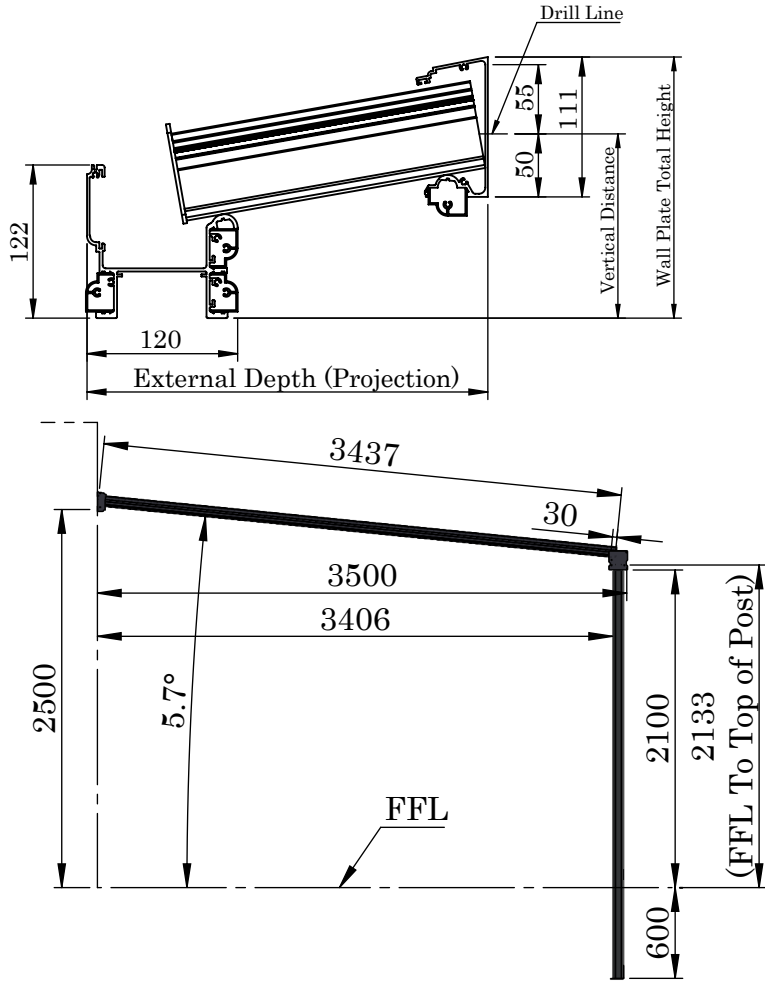

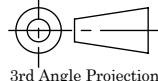
RAL Code	RAL 7016 Anthracite Grey Textured	Warehouse	Customer Reference : Sim 6	Drawing Title : Milwood Group					
Colour & Finish of Canopy			Customer Sign :	Product Name : Simplicity 6					
System Delivery Address		Checked By :	Order No. :	 3rd Angle Projection	Page 2 OF 7	Date 27/02/24	Page Size A4 (L)	Scale NTS	Drawn VA
Post Code :					Finish PPC	Issuer ACS	(Tol) +/- 1 mm	Sequence 000001	Revision V1.0
Post Code for installation :	Delivery Date :								

IMPORTANT - Please ensure you confirm the CAD version number in your CAD approval email to projects@milwoodgroup.com and/or attach the PDF you are approving.
Any approvals received without confirmation of the version **WILL NOT** be processed into manufacturing.

PRODUCT DETAIL

Wall Plate & Roof Bar Section

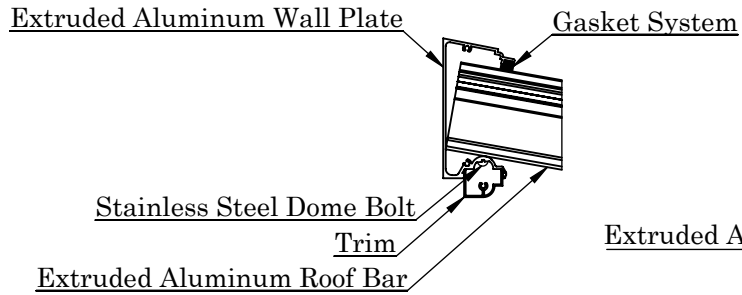

Roof Bar & Sheet Section

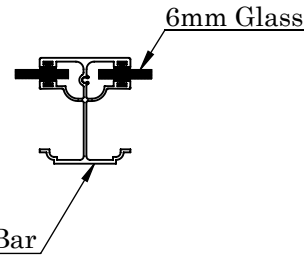

Base & Post Connection Information

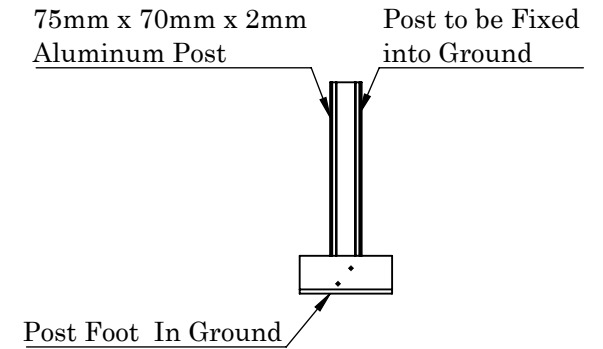

Eaves Beam Roof Bar & Post Section

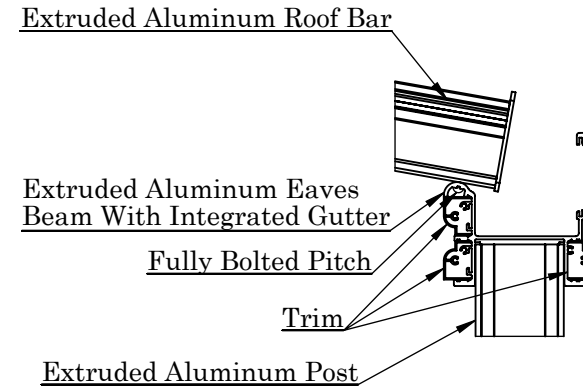

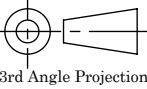
RAL Code	RAL 7016 Anthracite Grey Textured	Warehouse	Customer Reference : Sim 6	Drawing Title : Milwood Group					
Colour & Finish of Canopy			Customer Sign :	Product Name : Simplicity 6					
System Delivery Address		Checked By :	Order No. :	 3rd Angle Projection	Page 3 OF 7	Date 27/02/24	Page Size A4 (L)	Scale NTS	Drawn VA
Post Code :					Finish PPC	Issuer ACS	(Tol) +/- 1 mm	Sequence 000001	Revision V1.0
Post Code for installation :	Delivery Date :								

IMPORTANT - Please ensure you confirm the CAD version number in your CAD approval email to projects@milwoodgroup.com and/or attach the PDF you are approving.
Any approvals received without confirmation of the version **WILL NOT** be processed into manufacturing.

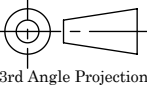
ITEM NO.	Simplicity 6 RAL 7016 Anthracite Grey TEXTURED					Items Cut/Pack	Quality Checked	Packed & Ready for Dispatch		
	PRODUCT CODE	DESCRIPTION	QTY.	LENGTH	Size Checked					
CUTTING LIST - Simplicity 6 RAL 7016 Anthracite Grey TEXTURED										
1	S6/MB/7016/7M	RAL7016 Anthracite Grey Sim 6 Main Bar (FTX) 7M	8	3437mm						
2	S6/LENSB/7016	RAL7016 Anthracite Grey Sim 6 Lens Glazing Bar (FTX)	0							
3	LIGHT/LENS8	Plastic 8mm Lighting Lens for Sim 6	0							
4	S6/EB/7016	RAL7016 Anthracite Grey Sim 6 End Bar (FTX)	2	3437mm						
5	S6/S16/WP/7016	RAL7016 Anthracite Grey Sim 6 & 16 Wall Plate (FTX)	1	6000mm						
6	S6/S16/GUT/7016	RAL7016 Anthracite Grey Sim 6 & 16 Gutter (FTX)	1	6000mm						
7	S6/S16/TRIM/7016	RAL7016 Anthracite Grey Sim 6 & 16 Gutter & Wall Plate Trim (FTX)	4	6000mm						
8	S6/SF/FSEC/7016	RAL7016 Anthracite Grey Sim 6 F Section / Sim Free F Section (FTX)	9	600mm						
9	S6/S16/STDPOST/7016	RAL7016 Anthracite Grey Sim 6 & 16 Standard Post (FTX)	3	3000mm						
10	S6/S16/SQPOST/7016	RAL7016 Anthracite Grey Sim 6 & 16 Square Post (FTX)	0							
11	SX/POST/7016/6M	RAL7016 Anthracite Grey Simplicity Xtra Post (FTX) 6M	0							
12	S6/BARGAS/WP	Sim 6 Wall Plate Gasket	1	6000mm						
13	S6/BARGAS/TOP	Sim 6 Glazing Bar Top Gasket	18	3437mm						
14	S6/BARGAS/BOT	Sim 6 Glazing Bar Bot Gasket	18	3437mm						
15	S6/INF/7016	RAL7016 Anthracite Grey Sim 6 Gutter Infill (FTX)	2	2885mm						
16	DRAIN/SQDP/BL	Black Square Downpipe 5.5m 65mm	2	2750mm						
17	DRAIN/INTDP	40mm Internal Kit Down Pipe 3m	0							
FIXTURES LIST - SIM 6 COMPONENTS										
18	Fastener 25	M5 Black Domed Hex Head Cap	79							
19	Fastener 10	no 10 x 1 hex self tapper ab zp din.7976c zinc plated	26							
20	Fastener 31	M6x20 Pan Pozi Screw	48							
21	Fastener 2	No12 x Self Driller 1/1.4	53							
22	Fastener 3	M6 NYLOC INSERT NUT ST/ST A4	48							
RAL Code		RAL 7016 Anthracite Grey Textured		Warehouse	Customer Reference : Sim 6		Drawing Title : Milwood Group			
Colour & Finish of Canopy					Product Name : Simplicity 6					
System Delivery Address		Checked By :	Customer Sign :		 3rd Angle Projection	Page	Date	Page Size	Scale	Drawn
Post Code :			Order No. :			4 OF 7	27/02/24	A4 (L)	NTS	VA
Post Code for installation :			Delivery Date :		Finish	Issuer	(Tol) +/- 1 mm	Sequence	Revision	
				PPC	ACS		000001	V1.0		

IMPORTANT - Please ensure you confirm the CAD version number in your CAD approval email to projects@milwoodgroup.com and/or attach the PDF you are approving.
Any approvals received without confirmation of the version **WILL NOT** be processed into manufacturing.

ITEM NO.	PRODUCT CODE	DESCRIPTION	QTY.	LENGTH	Size Checked	Items Cut/Pack	Quality Checked	Packed & Ready for Dispatch
END PLATES LIST - SIM 6 COMPONENTS								
23	S6/S16/MBEND/7016	RAL7016 Anthracite Grey Sim 6 & 16 Main Bar End Plate (FTX)	8					
24	S6/BARENDOFF/7016	RAL7016 Anthracite Grey Sim 6 Bar End Plate Offset Hole	2					
25	S6/S16/WPEND/7016	RAL7016 Anthracite Grey Sim 6 & 16 Wall Plate End Plate (FTX)	2					
26	S6/S16/SLOTGUTEND/7016	SLOTTED Sim 6 & 16 Gutter End Plate 7016 (FTX)	2					
27	SX/POSTEND/7016	RAL7016 Anthracite Grey Sim Xtra Post End Plate (FTX)	0					
VICTORIAN UPGRADES - SIM 6 COMPONENTS								
28	VIC/BASE/7016	RAL7016 Anthracite Grey Victorian Base Casting 6 & 16 (FTX)	0					
29	VIC/BRA/7016	RAL7016 Anthracite Grey Gallows Bracket 300mm x 300mm (FTX)	0					
DRAINAGE LIST - SIM 6 COMPONENTS								
30	DP/SHOE/BLACK	Black Down Pipe Shoe	2					
31	DRAIN/DPCLIP/BL	Single Fix Square Downpipe Clip Black	4					
32	DRAIN/SQ90	Black Square Bend 90 degrees	0					
33	DRAIN/112/BL	112 Degree Square Downpipe Bend Black	0					
34	DRAIN/SWIV	40mm Internal Kit Swivel Bend	0					
35	DRAIN/STRJOI	40mm Internal Straight Joiner	0					
36	SNUG/BLACK	Black Pipe Snug	0					
37	DRAIN/SPIG	Downpipe Spigot	2					

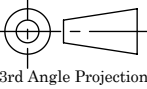
RAL Code	RAL 7016 Anthracite Grey Textured	Warehouse	Customer Reference : Sim 6	Drawing Title : Milwood Group					
Colour & Finish of Canopy			Customer Sign :	Product Name : Simplicity 6					
System Delivery Address		Checked By :	Order No. :	 3rd Angle Projection	Page 5 OF 7	Date 27/02/24	Page Size A4 (L)	Scale NTS	Drawn VA
Post Code :					Finish PPC	Issuer ACS	(Tol) +/- 1 mm	Sequence 000001	Revision V1.0
Post Code for installation :	Delivery Date :								

IMPORTANT - Please ensure you confirm the CAD version number in your CAD approval email to projects@milwoodgroup.com and/or attach the PDF you are approving.
Any approvals received without confirmation of the version **WILL NOT** be processed into manufacturing.

ITEM NO.	PRODUCT CODE	DESCRIPTION	QTY.	LENGTH	Size Checked	Items Cut/Pack	Quality Checked	Packed & Ready for Dispatch
JOINERS - SIM 6 COMPONENTS								
38	S6/S16/GUTJ/7016	Sim 6 & 16 18x300 Gutter Joiner 7016	0					
39	S6/S16/GUTJ2/7016	RAL7016 Anthracite Grey Sim 6 & 16 61.5 x 300 Gutter Joiner 2 (FTX)	0					
40	S6/S16/GUTJ3/7016	RAL7016 Anthracite Grey Sim 6 & 16 70 x 300 Gutter Joiner 3	0					
GLASS JOINERS - SIM 6 COMPONENTS								
41	PLASJOI/BL	Black Plastic Joiner	0					
42	INF/CLEAR	6mm Solid Clear Infill	0					
POST BRACKETS - SIM 6 COMPONENTS								
43	GEN/BRA	Generic In Ground Post Bracket	3					
44	S6/S16/BTGBRA/7016	RAL7016 Anthracite Grey Sim 6 & 16 Bolt To Ground Post Bracket (FTX)	0					
45	SX/BTGBRA/7016	RAL7016 Anthracite Grey Sim Xtra Bolt To Ground Bracket (FTX)	0					
SILICONE & SPRAY CANS - SIM 6 COMPONENTS								
46	SOUD/BL	Soudall Black	1					
47	AERO/7016	Spray Can RAL7016 Anthracite Grey Textured	1					
GLASS								
48	SCGL/6/CLEAR	6mm Self Cleaning Activ Clear Glass	0					
49	SCGL/6/BLUE	6mm Self Cleaning Activ Blue Glass	0					
50	GL/6/ACTV/BLUE	6mm Blue Activ/Solar Tinted Glass	0					
51	GL/6/BRONZE	6mm Bronze Tinted Glass	0					
52	GL/6/GREEN	6mm Green Tinted Glass	0					
53	GL/6/GREY	6mm Grey Tinted Glass	0					
54	GL/6/CLEAR	6mm Clear Glass	9		Length- 3437mm x Width-640mm			

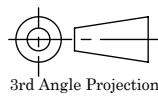
RAL Code		RAL 7016 Anthracite Grey Textured		Warehouse	Customer Reference : Sim 6		Drawing Title : Milwood Group				
Colour & Finish of Canopy					Product Name : Simplicity 6						
System Delivery Address		Checked By :		Customer Sign :		 3rd Angle Projection	Page	Date	Page Size	Scale	Drawn
Post Code :				Order No. :			6 OF 7	27/02/24	A4 (L)	NTS	VA
Post Code for installation :		Delivery Date :		Finish	Issuer	(Tol) +/-	Sequence	Revision			
				PPC	ACS	1 mm	000001	V1.0			

IMPORTANT - Please ensure you confirm the CAD version number in your CAD approval email to projects@milwoodgroup.com and/or attach the PDF you are approving.
Any approvals received without confirmation of the version **WILL NOT** be processed into manufacturing.

Glass Detail

Glass Type	6mm Clear Glass
No Of Glass Panel	9
Glass m ²	19.79 m ²

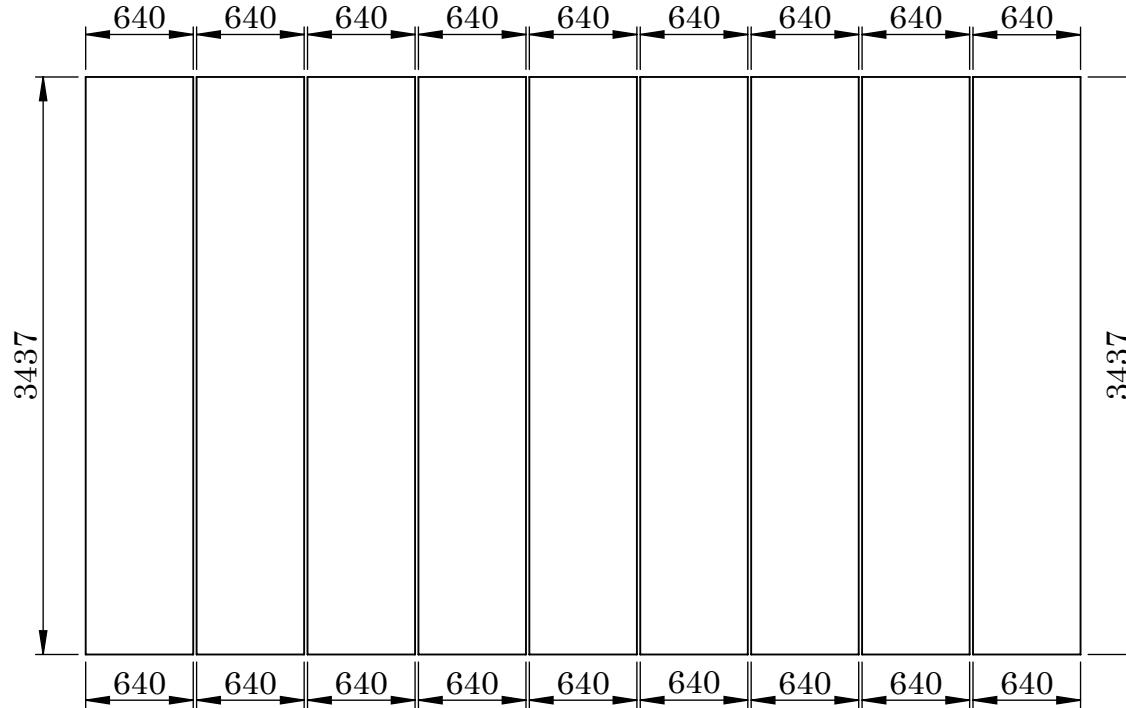

GLASS SIZE

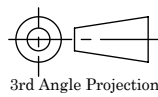
RAL Code	RAL 7016 Anthracite Grey Textured	Warehouse	Customer Reference : Sim 6	Drawing Title : Milwood Group					
Colour & Finish of Canopy				Product Name : Simplicity 6					
System Delivery Address		Checked By :	Customer Sign :	 3rd Angle Projection	Page	Date	Page Size	Scale	Drawn
Post Code :			Order No. :		7 OF 7	27/02/24	A4 (L)	NTS	VA
Post Code for installation :			Delivery Date :	Finish	Issuer	(Tol) +/-	Sequence	Revision	
		PPC	ACS	1 mm	000001	V1.0			